

**1.60mm Height Top View Full Color Chip LEDs
With Built-in WS281B Driver
Technical Data Sheet**

Part No.: DL-TOP5050RGBC-WS2812B

Double Light

◆ Features and Benefits

1. Control circuit and RGB chip are integrated in a package of 5050 components, form a complete control of pixel point.
2. Built-in signal reshaping circuit, after wave reshaping to the next driver, ensure wave-form distortion not accumulate.
3. Built-in electric reset circuit and power lost reset circuit.
4. Each pixel of the three primary color can achieve 256 brightness display, completed 16777216 color full color display, and scan frequency not less than 400Hz/s.
5. Cascading port transmission signal by single line.
6. Any two point the distance more than 5m transmission signal without any increase circuit.
7. When the refresh rate is 30fps, low speed model cascade number are not less than 512 points, high speed mode not less than 1024 points.
8. Send data at speeds of 800Kbps.
9. The color of the light were highly consistent, cost-effective.

◆ Applications

1. Full-color module, Full color soft lights a lamp strip.
2. LED decorative lighting, Indoor/outdoor LED video irregular screen.

◆ General description

1. DL-TOP5050RGBC-WS2812B is a intelligent control LED light source that the control circuit and RGB chip are integrated in a package of 5050 components. It internal includes intelligent digital port data latch and signal reshaping amplification drive circuit. Also include a precision internal oscillator and a 12V voltage programmable constant current control part, effectively ensuring the pixel point light color height consistent.
2. The data transfer protocol use single NZR communication mode. After the pixel power-on reset, the DIN port receive data from controller, the first pixel collect initial 24bit data then sent to the internal data latch, the other data which reshaping by the internal signal reshaping amplification circuit sent to the next cascade pixel through the DO port. After transmission for each pixel, the signal to reduce 24bit. pixels adopt auto reshaping transmit technology, making the pixel cascade number is not limited the signal transmission, only depend on the speed of signal transmission.
3. LED with low driving voltage, environmental protection and energy saving, high brightness, scattering angle is large, good consistency, low power, long life and other advantages. The control chip integrated in LED above becoming more simple circuit, small volume, and convenient installation.

Double Light

◆ Mechanical Dimensions

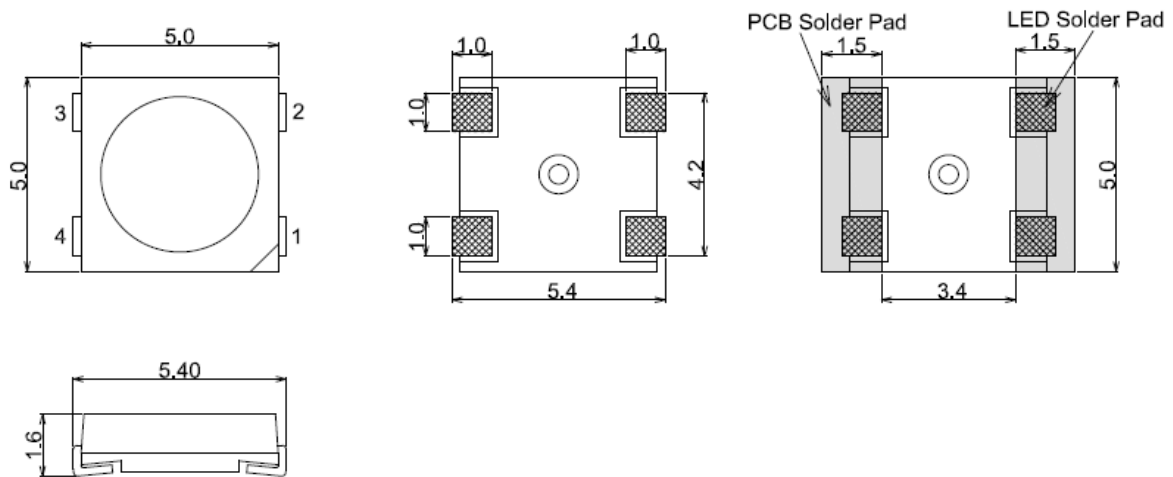

Part No.	Chip Material		Lens Color	Source Color
DL-TOP5050RGB-WS2812B	R	AlGaInP	Water Clear	Hyper Red
	G	InGaN		Pure Green
	B	InGaN		Blue

◆ PIN configuration

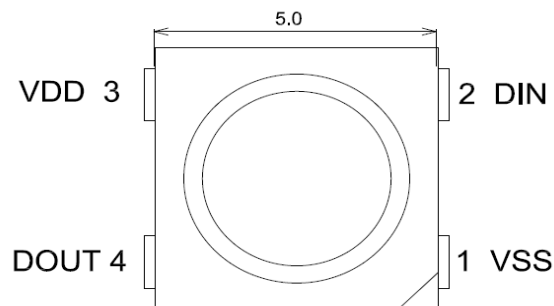

PIN function

No.	Symbol	Function description
1	VSS	Ground
2	DIN	Control data signal input
3	VDD	Power supply LED
4	DOUT	Control data signal output

Double Light

◆ Electrical Characteristics (TA=-20 ~ +70°C , VDD=4.5 ~ 5.5V,VSS=0V,unless otherwise specified)

Parameters	Symbol	Conditions	Min	Tpy	Max	Unit
Low voltage output current	IOL	ROUT	--	18.5	--	mA
	Idout	Vo=0.4V, DOUT	10	--	--	mA
Input current	II	VI=VDD/VSS	--	--	±1	μA
Input voltage level	VIH	DIN, SET	0.7VDD	--	--	V
	VIL	DIN, SET	--	--	0.3 VDD	V
Hysteresis voltage	VH	DIN, SET	--	0.35	--	V

◆ Switching characteristics (TA=-20 ~ +70°C , VDD=4.5 ~ 5.5V,VSS=0V,unless otherwise specified)

Parameters	Symbol	Conditions	Min	Tpy	Max	Unit
Operation frequency	Fosc2	--	--	1.5	--	KHz
Transmission delay time	tPLZ	CL=15pF,DIN→DOUT,RL=10KΩ	--	--	300	ns
Fall time	tTHZ	CL=300pF,OUTR/OUTG/OUTB	--	--	120	μs
Data transmission rate	FMAX	Duty ratio50%	400	--	--	Kbps
Input capacity	CI	--	--	--	15	pF

◆ LED characteristic parameter

Emitting color	Wavelength(nm)	Luminous intensity(mcd)	Current(mA)	Voltage(V)
Red	620-630	550-700	20	1.8-2.2
Green	515-530	1100-1400	20	3.0-3.2
Blue	465-475	200-400	20	3.2-3.4

◆ Data transfer time (TH+TL=1.25μs±600ns)

T0H	0 code ,high voltage time	220-480ns
T1H	1 code ,high voltage time	750ns-2us
T0L	0 code , low voltage time	750ns-2us
T1L	1 code ,low voltage time	220-480ns
RES	low voltage time	Above 300μs

Double Light

◆ Sequence chart:

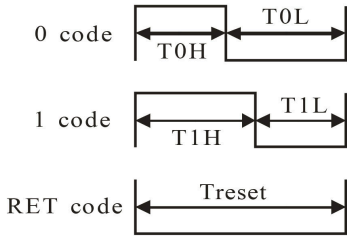

◆ Cascade method:

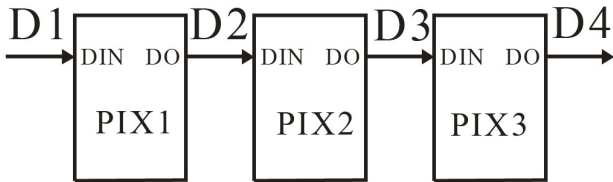

◆ Data transmission method:

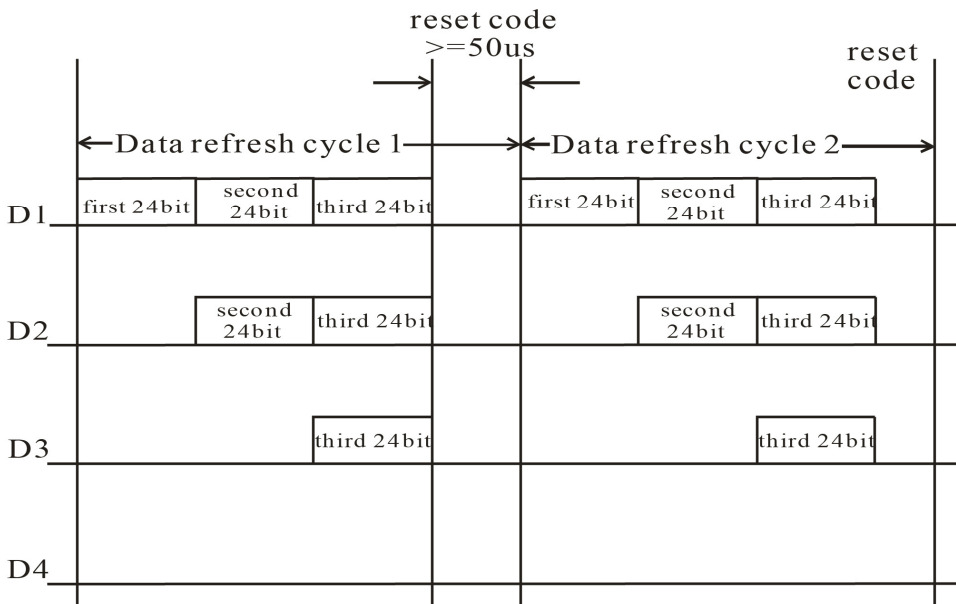

Note: The data of D1 is send by MCU, and D2, D3, D4 through pixel internal reshaping amplification to transmit.

◆ Composition of 24bit data:

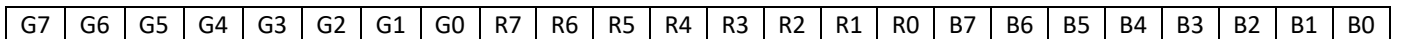

Note: Follow the order of GRB to send data and the high bit sent at first.

◆ Typical application circuit:

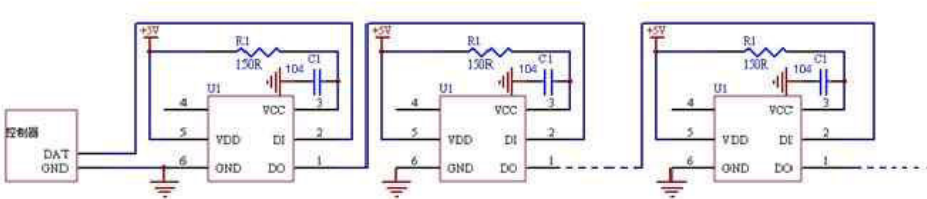

Double Light

◆ Typical Electrical / Optical Characteristics Curves

(25°C Ambient Temperature Unless Otherwise Noted)

Hyper Red:

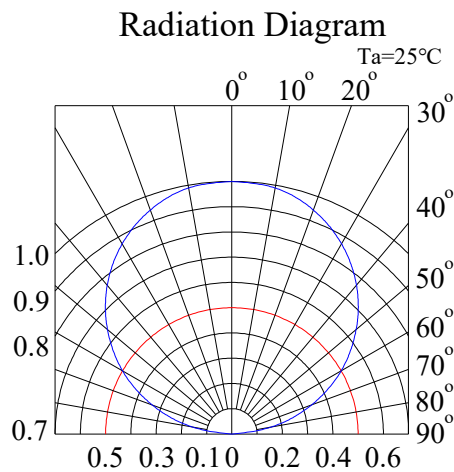
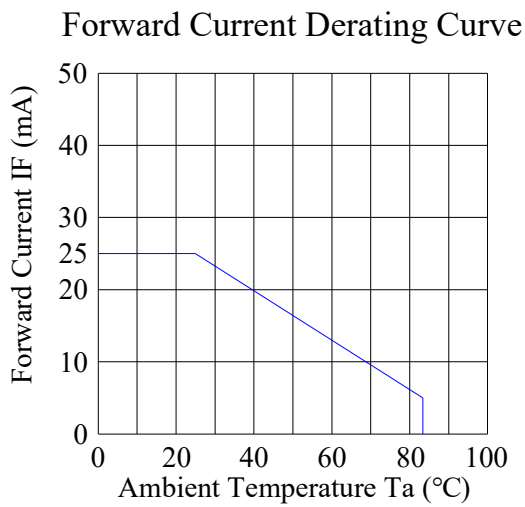
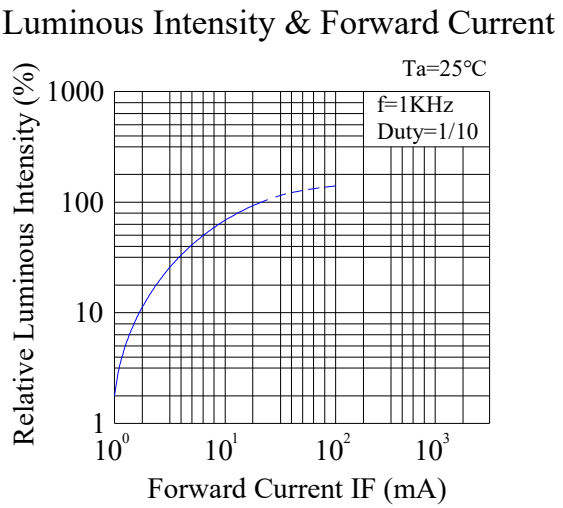
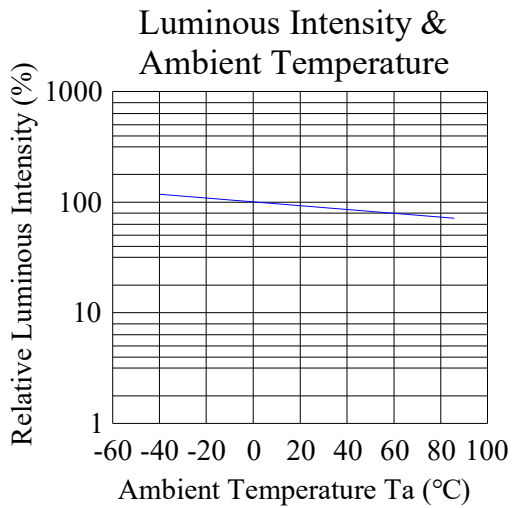
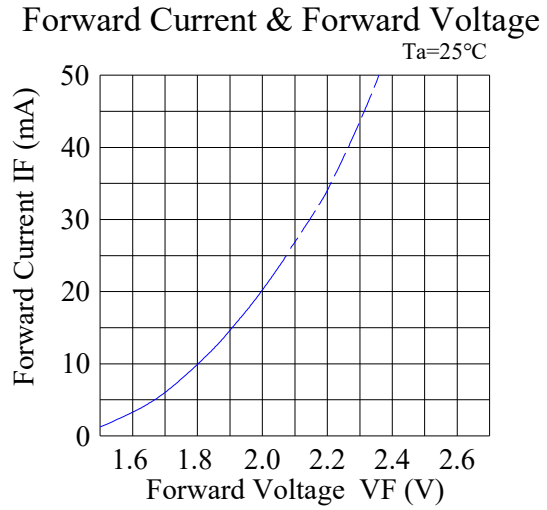
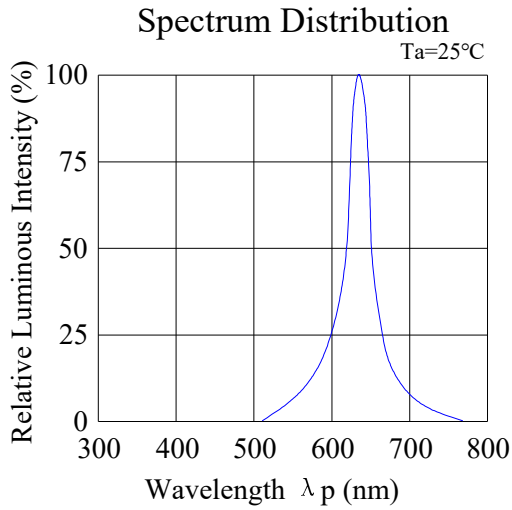

Double Light

Pure Green:

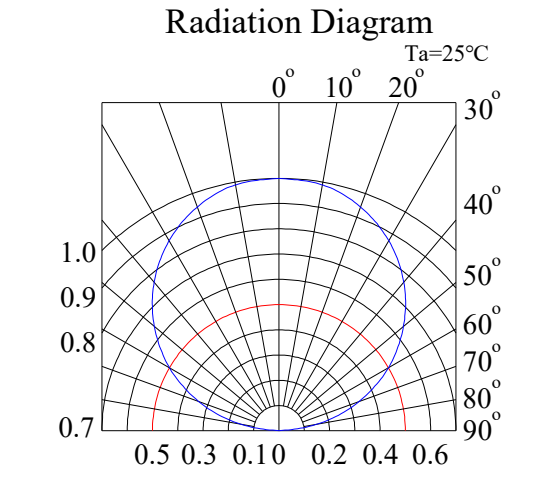
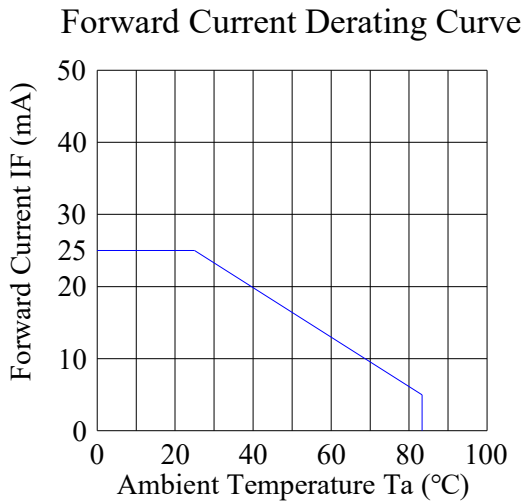
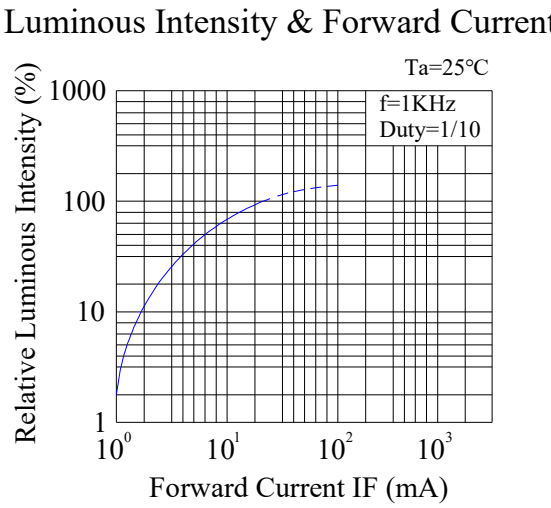
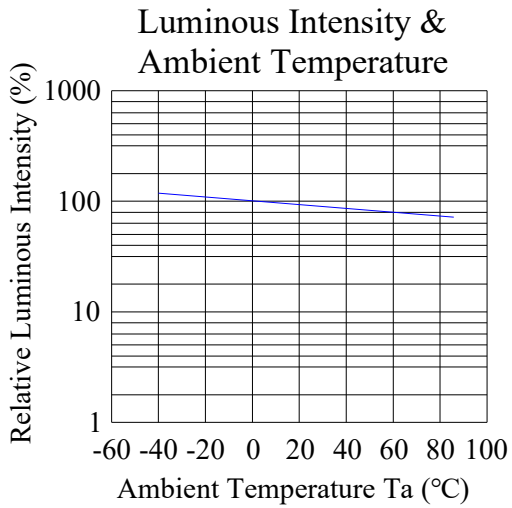
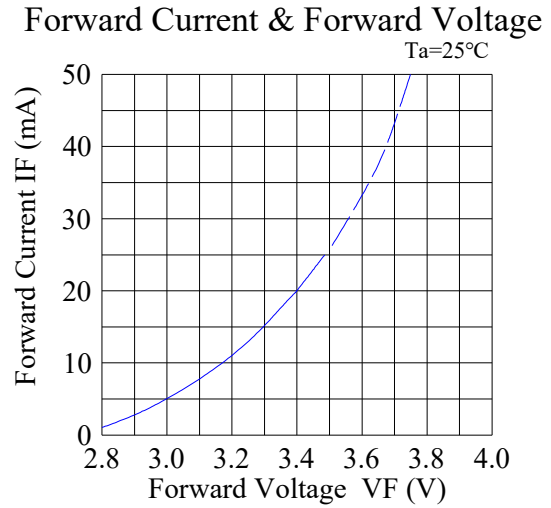
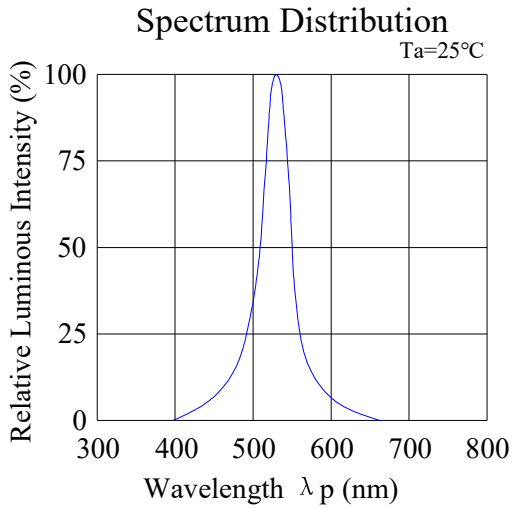

Double Light

Blue:

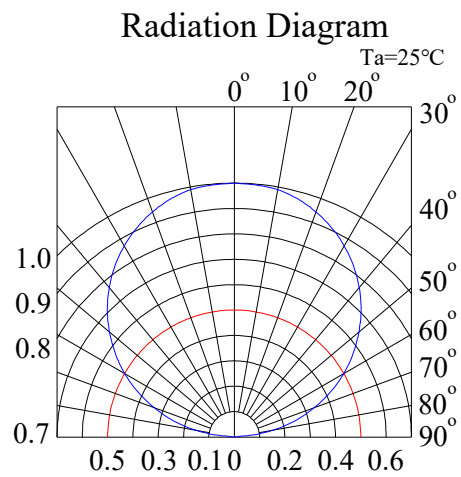
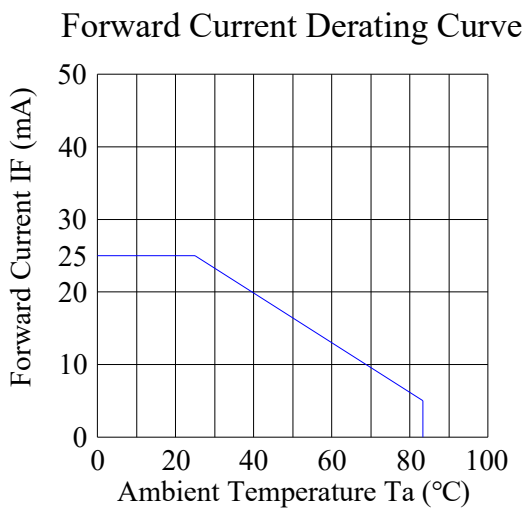
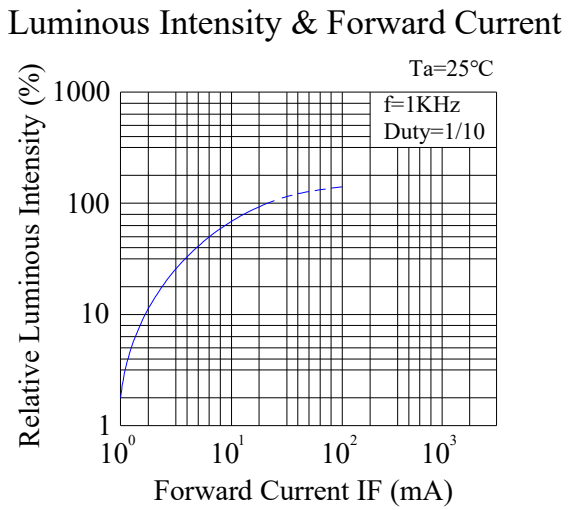
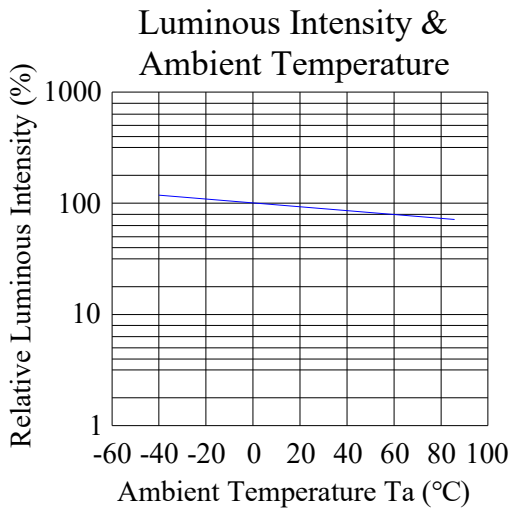
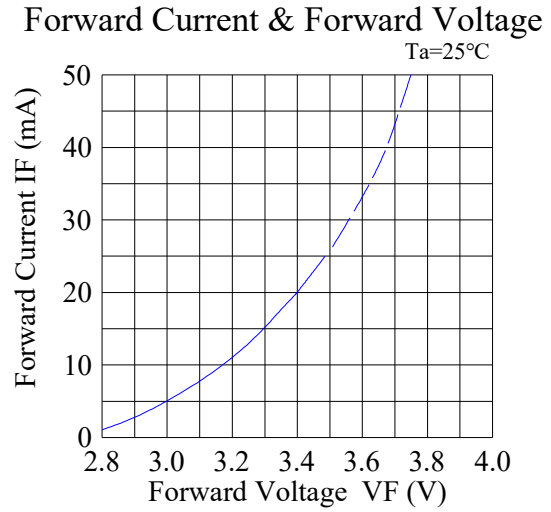
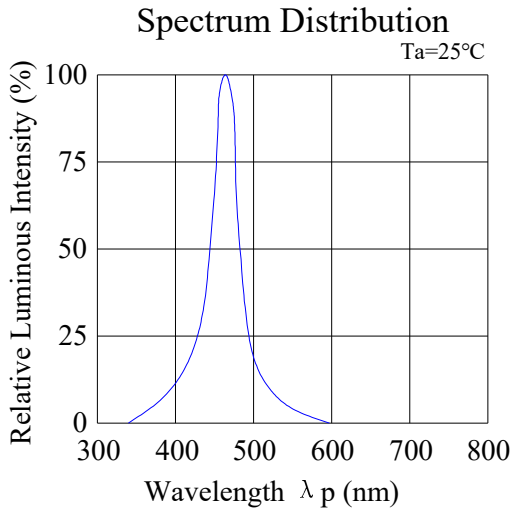

Double Light

◆ Reliability Test Items And Conditions (Per Chip):

The reliability of products shall be satisfied with items listed below:

Confidence level: 90%.

LTPD: 10%.

1) Test Items and Results:

No.	Test Item	Test Hours/Cycles	Test Conditions	Sample Size	Ac/Re
1	Resistance to Soldering Heat	6 Min	Tsld=260±5℃, Min. 5sec	25pcs	0/1
2	Thermal Shock	300 Cycles	H: +100℃ 5min J 10 sec L: -10℃ 5min	25pcs	0/1
3	Temperature Cycle	300 Cycles	H: +100℃ 15min J 5min L: -40℃ 15min	25pcs	0/1
4	High Temperature Storage	1000Hrs.	Temp: 100℃	25pcs	0/1
5	DC Operating Life	1000Hrs.	IF=20mA	25pcs	0/1
6	Low Temperature Storage	1000Hrs.	Temp: -40℃	25pcs	0/1
7	High Temperature/ High Humidity	1000Hrs.	85℃/85%RH	25pcs	0/1

2) Criteria for Judging the Damage:

Item	Symbol	Test Conditions	Criteria for Judgment	
			Min	Max
Forward Voltage	VF	IF=20mA	---	F.V.*)×1.1
Reverse Current	IR	VR=5V	---	F.V.*)×2.0
Luminous Intensity	IV	IF=20mA	F.V.*)×0.7	---

*) F.V.: First Value.

Double Light

Please read the following notes before using the product:

1. Over-current-proof

Customer must apply resistors for protection, otherwise slight voltage shift will cause big current change (Burn out will happen).

2. Storage

2.1 Do not open moisture proof bag before the products are ready to use.

2.2 Before opening the package, the LEDs should be kept at 30°C or less and 90%RH or less.

2.3 The LEDs should be used within a year.

2.4 After opening the package, the LEDs should be kept at 30°C or less and 70%RH or less.

2.5 The LEDs should be used within 168 hours (7 days) after opening the package.

2.6 If the moisture adsorbent material (silica gel) has fabled away or the LEDs have exceeded the storage time, baking treatment should be performed using the following conditions. Baking treatment: 60±5°C for 24 hours.

3. Soldering Condition

3.1 Pb-free solder temperature profile.

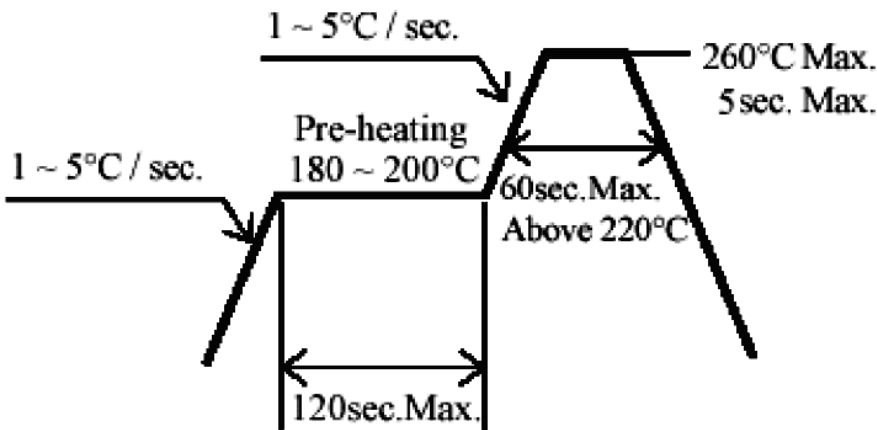

3.2 Reflow soldering should not be done more than two times.

3.3 When soldering, do not put stress on the LEDs during heating.

3.4 After soldering, do not warp the circuit board.

4. Soldering Iron

Each terminal is to go to the tip of soldering iron temperature less than 260°C for 5 seconds within once in less than the soldering iron capacity 25W. Leave two seconds and more intervals, and do soldering of each terminal. Be careful because the damage of the product is often started at the time of the hand solder.

5. Repairing

Repair should not be done after the LEDs have been soldered. When repairing is unavoidable, a double-head soldering iron should be used (as below figure). It should be confirmed beforehand whether the characteristics of the LEDs will or will not be damaged by repairing.

Double Light

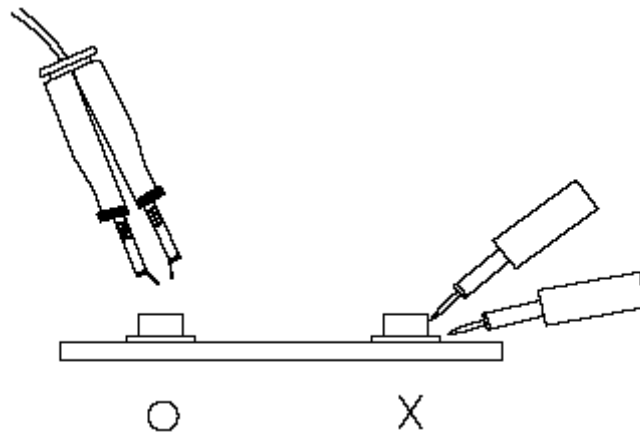

6. Caution in ESD

Static Electricity and surge damages the LED. It is recommended to use a wrist band or anti-electrostatic glove when handling the LED. All devices, equipment and machinery must be properly grounded.